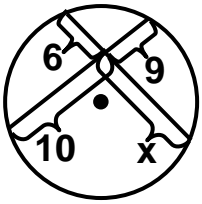
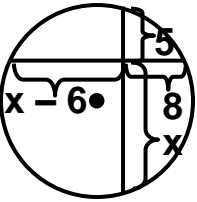
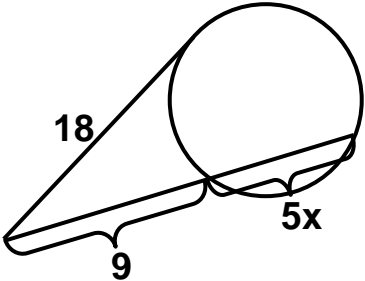
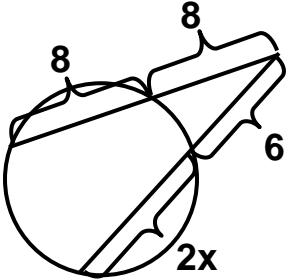
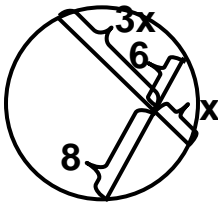
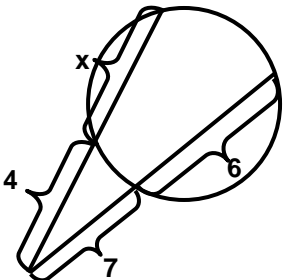
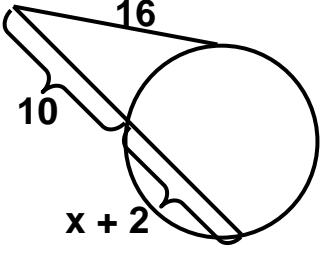
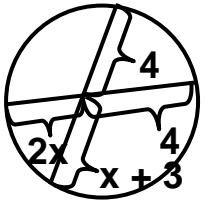
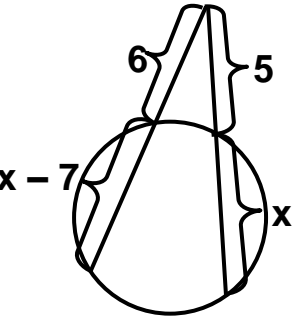
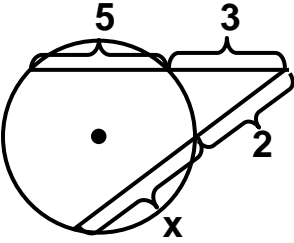
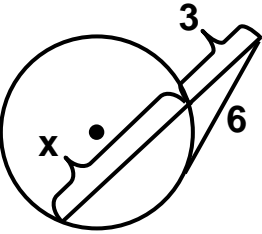

NAME _____ DATE _____ PER. _____

SPECIAL SEGMENTS IN CIRCLES

Find the value of 'x' in each of the following.

<p>1. $x =$ _____</p>	
<p>2. $x =$ _____</p>	
<p>3. $x =$ _____</p>	
<p>4. $x =$ _____</p>	
<p>5. $x =$ _____</p>	
<p>6. $x =$ _____</p>	

<p>7. $x =$ _____</p>	
<p>8. $x =$ _____</p>	
<p>9. $x =$ _____</p>	
<p>10. $x =$ _____</p>	
<p>11. $x =$ _____</p>	

Find the length of the radius.

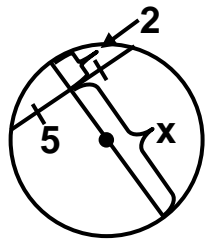
<p>12. $r =$ _____</p>	
-----------------------------------	---

REVIEW PROBLEMS

Find the circumference and area of each circle.

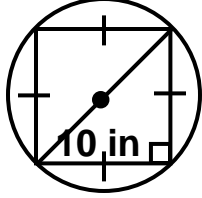
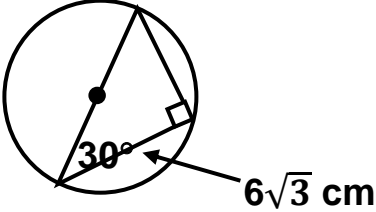
<p>13. $C =$ _____ $A =$ _____</p>	
<p>14. $C =$ _____ $A =$ _____</p>	

Find the value of 'x'.

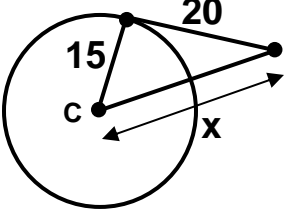
<p>15. $x =$ _____</p>	
<p>16. $x =$ _____</p>	